

vatti

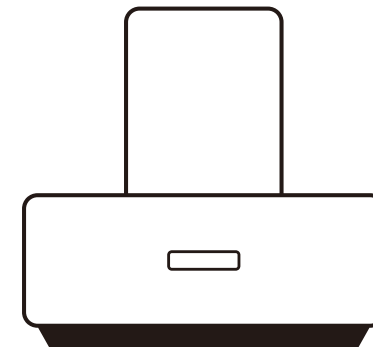

RANGE HOOD
(V917)



Instruction manual

PLEASE READ THE INSTRUCTION MANUAL CAREFULLY
BEFORE USING THE PRODUCT AND KEEP IT PROPERLY!



VATTI (M) SDN BHD
202101045273 (1445573-P)
Unit D5-08-01, Pusat Perdagangan Dana 1,
Jalan PJU 1A/46, 47301 Petaling Jaya.
enquiry@vattimalaysia.com



Attention:

Important

For safety purpose, you should read the instructions carefully before using the appliance for the first time. Save the instruction for future reference.

The appliance is designed for domestic use and may only be installed and operated in accordance with these instructions for use.

If there is any malfunction arise during the operation, please contact with us timely on service :enquiry@vattimalaysia.com . If you contact unauthorized service agent, we will not responsible for your lost.



Table of Content

User Environmental Announcement	1
Installation requirements	2
Safety Precautions	3
Safety Instruction	5
Technical Parameter	6
Product Image	7
Spare Part List	8
Packing List	9
Installation Method	9
How To Use	12
Maintenance	17
Disassembly And Clean	18
Trouble Shooting	19
Error Code Trouble Shooting	20
After Sales Service	21



User Environmental Announcement

"To protect the environment, benefit people, prevent pollution, and continuously improvement" The purpose and direction is our environmental management. In accordance with the Standards system of GB/T 24001-2016 / IDT ISO 14001:2015, we establish and implement the principles to protect the environmental management systems.

There are two environmental Announcements during use and after use:

1, Waste cartons and plastic bags are recyclable wastes, and waste foam plastics are non-recyclable wastes.

Please throw it into the designated classified trash bin after unpacking.

2, Any of the product has a service life, we recommended the service life of the range hood is 8 years. For the wasted products, please handle it properly so as not to pollute the environment.



After-sales Service

Warranty for VATTI Products

Warranty effective only for original buyers, and it is necessary for VATTI products buy only from authorized dealers;

For warranty claim, it is necessary to fill up warranty card properly and completely time of purchase;

Any kind of VATTI product warranty claim based on manufacture defect or poor workmanship under the normal use;

Product warranty period and maintenance are as per VATTI Malaysia policy;

In case of providing home service, visit charges will be applicable as per policy;

Those who fall into one of the following situations are not covered by the free maintenance:

- a. Damage caused by improper use;
- b. Damage caused by non-VATTI service outlet installation, disassembly and maintenance;
- c. Cannot provide warranty card or valid purchase certificate, or the warranty card and valid certificate have been altered.
- d. The product model and product serial number on the warranty card or valid purchase certificate do not match the product model and serial number being repaired.
- e. Electric short circuit, voltage fluctuation, poor wiring, wrong use, miss parts, accidental damage and force majeure;
- f. Products that exceed the warranty period;

If the product fails out of the warranty period, VATTI after-sales outlets will also provide you with warm, thoughtful and timely paid services as per policy.

• Aftersales Process

1. If the product is in fault, contact VATTI Malaysia service:

enquiry@vattimalaysia.com

If users take product to unauthorized service network for maintenance, all consequences arising therefrom shall be borne by the user.

2. VATTI service network will response as soon as possible when getting the service information. According to users' feedback, service staff will judge the fault reasons and prepare the spare parts.



Installation Requirements



The installation process must be completed by appointed professional, and non-professionals are strictly prohibited from operating.

- Range hood should be installed directly above hob, the minimum distance between the bearing surface of hob and the lowest part of the range hood should be 65cm, if the installation instructions for hob specify a larger distance, which should be considered.
- The stretching distance of the flow pipe should be as short as possible, with less turning, and the angle of turning should be as large as possible to avoid excessive resistance and affecting the smoke exhausting effect.
- Range hood should be placed horizontally when installing to avoid the oil flowing out from the lower side during use.
- Flexible duct can be extended outdoors and discharged into the atmosphere directly, or discharged into the cold air public flue should be sealed. If the exhaust gas is discharged outdoors directly, the air outlet of the flexible duct should be placed in a sheltered place to prevent the exhaust fumes from flowing back.
- This machine is a Class I appliance. When the basic insulation protection is damaged, it relies on ground wire to the protection of electric shock, Therefore, the connection between the power socket and the ground wire must be ensured.
- The telescopic length of flow pipe is 1.8m, kindly please pay attention to the installation environment of the kitchen.
- The exposed length of power cord is about 1.5m, kindly please pay attention to the installation position of the socket.



Safety Precautions

Attention

1. Please operate the range hood in accordance with the instruction to avoid the property loss and personal injury.
2. In order to protect personal and property safety, Only qualified allowed to install, adjust and maintained the range hood, if any operator who was designated by the user, the user would take the risk of person injury and property loss.
3. If any provision of this specification is in conflict with the mandatory provisions of national law, the legal provisions shall prevail
4. This appliance can be used by children aged from 8 years and above and persons with reduced physical, sensory or mental capabilities or lack of experience and knowledge if they have been given supervision or instruction concerning use of the appliance in a safe way and understand the hazards involved. Children shall not play with the appliance. Cleaning and user maintenance shall not be made by children without supervision.
5. This appliance is not intended for use by persons (including children) with reduced physical, sensory or mental capabilities, or lack of experience and knowledge, unless they have been given supervision or instruction concerning use of the appliance by a person responsible for their safety. Children should be supervised to ensure that they do not play with the appliance.



Symptoms	Reasons	Solutions
Oil leak	Range hood install with angle	Install in horizontal position
	Duct set sealing broke	Replace sealing coil
	Oil occupied on hood	Clean the hood
Hot Wash Function Fault	Water pump error	Replace water pump
	Heating element error	Replace heating element
	Controller error	Replace controller
Lights no work	No connect to power	Check the cord and plug connect to power
	Lights broken up	Replace lights
Gesture Sensing Function Fault	Gesture Sensing window is dirty	Clean the Gesture Sensing window

Error Code Trouble Shooting

Error Code	Reasons	Solutions
F1	Motor stalled	Cut off the power supply and contact after-sales personnel for repair
F2	Motor phase loss	
F3	Hardware overcurrent	
F4	Software overcurrent	
F5	Voltage too high	
F6	Voltage too low	
F7	Startup failed	
F8	Back pressure too high	
F9	Temperature is high	
E5	Communication failure	

Attention

1. When use the range hood, in case of range hood broken, you should contact the maintenance staff if the heating element is broke.
2. When using the hot wash function, it is normal occasion for water spray sound, steam rustle sound and slight steam leak



Trouble Shooting

If the range hood is in abnormal status, cut off the power and contact maintenance staff. The table below is used for maintenance staff only. Non-specialized person cannot disassemble and repair the range hood.

Symptoms	Reasons	Solutions
Range hood no working	Do not connect to power	Check the cord and plug connect to power
	Fan block	Dismiss fan block
	Motor block	Lube or replace motor
	Motor broke	Replace motor
	Switch broke	Fix or replace switch
	Capacitor broke	Replace capacitor
	PCB broke	Replace PCB
Range hood abnormal knocking or shaking	Foreign object in hood cabinet	Dismiss foreign object
	Fan is not stable	Adjust or replace fan
	Bolt loose	Check and tighten the bolt
	Range hood is not in stable position	Install in stable position
	Fan broke	Replace fan
	Fan is not in good position	Fan installed in good position
	Motor is not in good position	Motor installed in good position
Range hood is not good suction performance	Range hood installed in too high position	Install the range hood in good height
	Too large negative pressure in kitchen	Open door or windows
	Withdrawal wind in duct	Change the duct exit to wind-proof place or put the duct exit downward
	Greasy duct pipe	Replace duct pipe
	Anti-backward cover block	Clean or replace anti-backward cover
	Motor speed decrease	Replace motor or capacitor

6. There shall be adequate ventilation of the room when the range hood is used at the same time as appliances burning gas or other fuels;

7. There is a fire risk if cleaning is not carried out in accordance with the instructions;

8. Do not flambé under the range hood;

9. CAUTION: Accessible parts may become hot when used with cooking appliances.

10. The air must not be discharged into a flue that is used for exhausting fumes from appliances burning gas or other fuels;

11. Regulations concerning the discharge of air have to be fulfilled.

12. Warning: Failure to install the screws or fixing device in accordance with these instructions may result in electrical hazards.

13. Range hoods and other cooking fume extractors may adversely affect the safe operation of appliances burning gas or other fuels (including those in other rooms) due to back flow of combustion gases. These gases can potentially result in carbon monoxide poisoning. After installation of a range hood or other cooking fume extractor, the operation of flued gas appliances should be tested by a competent person to ensure that back flow of combustion gases does not occur.



Safety Instruction

Dangerous

- The gas discharged by the smoke absorber should not be discharged into the hot flue used to discharge the smoke of combustion gas or other fuel to prevent the occurrence of fire.
- Do not bake directly to the range hood to prevent fire and damage.
- The room must be well ventilated when the hood is used in conjunction with a stove burning gas or other fuel. In case of incomplete combustion of gas poisoning
- The machine needs to use special single-phase two-pole with ground socket, and the ground wire of the socket must ensure reliable connection. Please ensure that electrical outlets are installed by a professional electrician and comply with the national and local regulations.
- If the power cord is damaged, it must be replaced by the manufacturer Or the professional engineer
- To avoid the electric shock hazard. Do not use wet hand to touch the power plug when electrical components and power switch were operating
- The range hood must be removed and cleaned in accordance with the instruction manual, otherwise fire and other dangerous accidents may occur.
- Packing plastic bags, foam and packing boxes are not toys. It is a high risk of suffocation on the head, please handle it properly. Keep packing materials away from children.
- Please unplug the power plug before cleaning and repairing to avoid electric shock.



Disassembly And Clean

Attention

1. This part must be conducted by maintenance staff;
2. The disassembled part should not be crushed or dropped in case of transformation or damage. It will influence the good performance of range hood;
3. The disassembly pictures are for reference only.

• Fan disassembly and clean

1. Cut off power connection for safety;
2. Discharge the chimneys, unfold the bolts on hood cabinet, unfold the bolts on air inlet part to discharge the air inlet part;
3. Unfold the fan tighten screw clockwise;
4. Put the discharged parts in to the neutral detergent water, use towel or brush to clean;
5. Assemble the clean parts vise versa;

• Removal and Cleaning of the Oil Cup (as shown in Figure)

Hold the oil cup with both hands and pull it in the direction of the arrow. When the oil cup buckle and the hook on the range hood are separated, you can take out the oil cup and pour out the oil. When taking out the oil cup, please keep it level to prevent the waste oil from overflowing. It is recommended to clean the oil cup at least once every six months. If there is condensed oil on the outer surface of the oil cup, please wipe it in time.

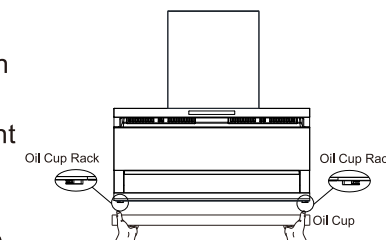

Hood Interior Cleaning (as shown in Figure)

- ① Please unplug the power cord first to ensure safety.
- ② Pull the movable glass open to any position and hover it, then you can clean the inside of the hood cavity.
- ③ After cleaning, push the movable glass back so that it is adsorbed on the magnet.

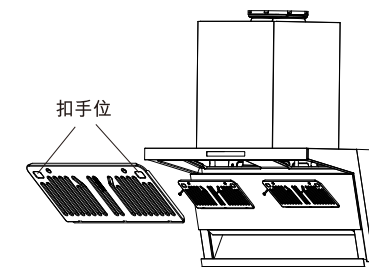



④ When the linkage function is enabled, the range hood is in the speed state, and when the gas hobs starts "🔥", the range hood automatically switches to the turbo state.

⑤ When the left and right knobs of the gas hobs are turned off or related cooking functions are turned off, the range hood enters the delayed shutdown state and automatically turns off after the delay ends.

Tips: Wireless communication is affected by the use environment or other wireless radio frequency devices, and the linkage function may be abnormally interrupted during use.

Maintenance

In order to keep good performance and prolong the lives of range hood, good maintenance is very important. Discharge the power connection when doing maintenance in case of safety.

- Keep the hood surface clean, use clean towel and neutral detergent only
- When the oil level is close to max line, pull away the oil in case of oil leak to pollute the kitchen and influence oil cup performance. Use strong acid or strong base detergent to clean oil cup.
- Deep clean the hood surface and oil filter net 1-3 months each time according to your use frequency.
- Do not use water to clean the range hood directly in case water damaging the electric parts. Any abnormal phenomenon happened, cut off the power connection.



	Forbid to modify the structure and inner line layout, it may course dangers like electrical shock and fire.
	Turn off the range hood once the wok/pan is on fire, distinguish the
	Strict implement fire by closing the gas regulator, covering the wok/pan by metal lid.
	Disconnect the electricity power source to avoid electrical shock once the range hood fault, or need installation and repair.
	Never operate the range hood once there was gas leakage but no fair. The operation may light the gas, and explosion may occur.

Technical Parameter

Model Number	V917
Power	220-240V~ 50 Hz
Maximum Static Pressure	900Pa
Motor Power	300W
Product Input Power	414W
Lamp	2x2W
Cleaning Pump Voltage/Power	110W
Air Flow (European Standard)	1200 m³/h
Turbo Air Flow (European Standard)	1500 m³/h
Unrestricted Airflow	2250m³/h
Size of External Diameter	Φ185 mm

Attention

The Variance data of the Actual and explicit values of the air flow, air pressure, and the maximum static pressure shall be not exceed -10 % of the stated value;



Product Image

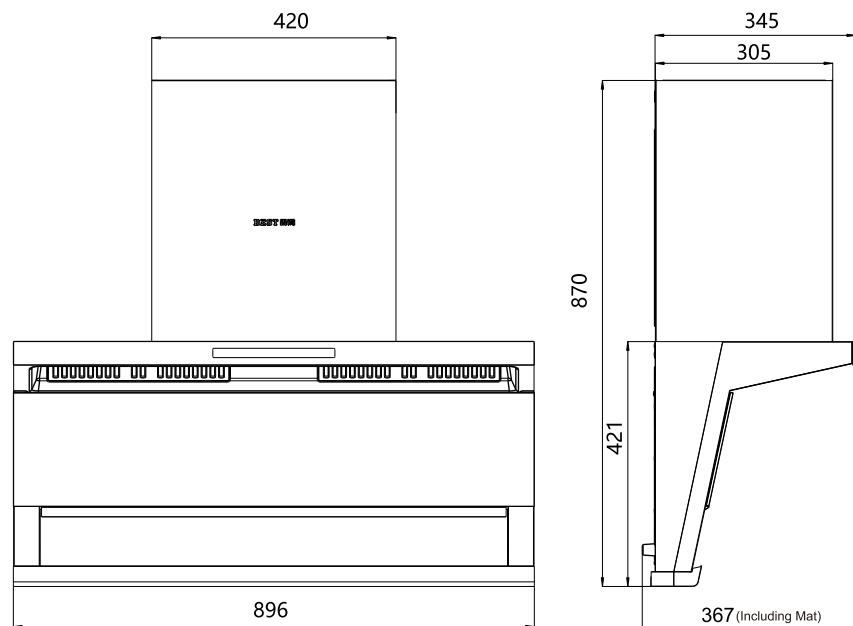

Unit:mm

⚠ Attention

- Diagram size is only for reference, if there is some deviation after the installation, it is recommended to reserve the unilateral not less than 5mm gap for the peripheral cabinets.

11. Hobs-to-hood Function

When used with the corresponding gas hobs, the range hood and hobs can be linked. The specific model is subject to the sales confirmation at the time of purchase.

(1) Linkage pairing

- ① Plug in the range hood and gas hobs (if powered by batteries, install the batteries) and make sure they are turned off.
- ② Touch the "⏻" button on the range hood to enter the standby state. At the same time, press and hold the "🔥" and "👉" buttons for 5 seconds to start pairing.
- ③ Ignite the gas hobs or start the relevant cooking function. When the range hood emits a "beep" sound, the "🔗" icon stays on, indicating that the pairing is successful and the range hood enters the speed function.

Note:

- If pairing is not successful within 30 seconds, the "🔗" icon goes out and needs to be re-paired. The operation method is the same as above.
- If the range hood or gas hobs electronic control board is replaced or repaired, re-pairing is required. The operation method is the same as above.

(2) Turning the linkage function on and off

- ① After pairing is successful, press and hold the "🔥" and "👉" buttons for 3 seconds at the same time in the standby state to turn off the linkage function, and the "🔗" icon goes out; press and hold the "🔥" and "👉" buttons for 3 seconds again to turn on the linkage function, and the "🔗" icon stays on.
- ② When the linkage function is enabled, the range hood automatically turns on and enters the wind speed function when the gas hobs is ignited or related cooking functions are started.
- ③ When the linkage function is started, the range hood is in the speed state, the gas hobs is ignited, and the range hood remains unchanged; when the related cooking functions are started, the corresponding speed is turned on.



- Washing cup must install in right position, or it will damage the range hood;
- Clean the washing cup after finish wash function;
- When use wash function, keep no food, flame under the hood in case of contamination or danger;
- Water used for washing must not higher then 40°C;
- Use stopper to block water suction mouth in case of oil block
- Wash steps are as follows, for reference only.

• Tips

- ① Remove the oil cup (when removing the oil cup, please keep the oil cup level to prevent waste oil from overflowing), wipe the oil stains on the bottom of the range hood and the bottom of the movable glass, and pull out the silicone plug of the water inlet;
- ② Take out the water suction nozzle assembly from the water cup and insert the water suction nozzle assembly into the water inlet hole;
- ③ Fill the clean water area of the water cup with clean water, and the water volume must exceed the minimum water volume line;
- ④ Hold both sides of the water cup with both hands, put the water suction nozzle assembly into the clean water area of the water cup, align the buckle on the water cup with the hook on the range hood, and push the water cup to the end with force;
- ⑤ In standby mode, press and hold the "Ⓞ" key for 3 seconds to start the cleaning function. If you need to cancel the cleaning function midway, press the "Ⓞ" or "⏻" key;
- ⑥ When the range hood emits 5 "beep beep" sounds, it indicates that the cleaning is complete. Please wait for about 2 minutes to drain the sewage before removing the water cup and water suction nozzle assembly, clean and dry them, and store them for later cleaning and use;
- ⑦ Clean and dry the silicone plug and oil cup, and then put them back to their original positions.

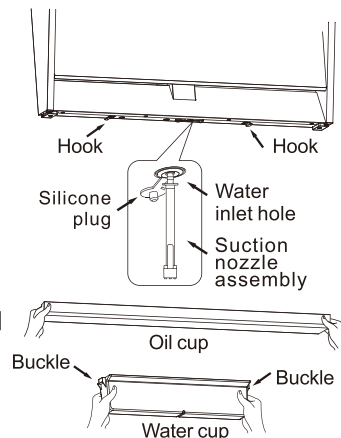

Spare Part List

The following product model structure diagram is a general simple structure diagram, only for users to identify the location of parts, if the graphics and the physical objects are inconsistent, please take the physical objects as the subject, Thanks for your attention!

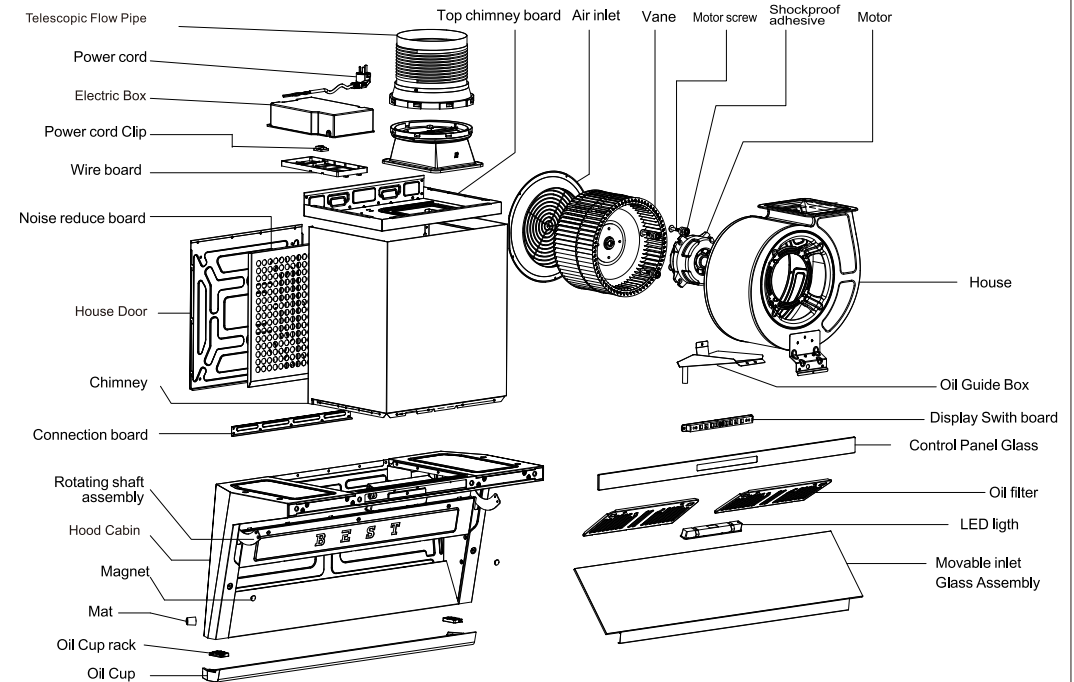



Packing List

Caution: Please check the products and accessories whether is complete according to below packing list.

No.	Item	Qty	Unit	Remarking
1	Range hood	1	pc	
2	Telescopic flow pipe	2	set	Install on the air outlet of the range hood
3	Hanger	1	pc	Fix the range hood on the wall
4	Oil cup	1	pc	Collect the dropping oils
6	Screw 5x50	3	pc	Screw into the plastic expansion tube, fix hanger
7	Φ10 plastic expansion tube	3	pc	Insert into the wall
8	Duct and cap	1	pc	Installed on the wall, to prevent rain, wind, birds to enter
11	Mat	2	pc	Assemble back of the range hood
12	Manual	1	pc	Please keep it safe
13	Serial number	2	pc	Please keep it safe
14	Aluminum tape	2	pc	Connect the tape and adaptor
15	Warranty card	1	pc	Please keep it safe
16	Screw M4x14	1	pc	Fix Braket

Caution

Kindly please contact with dealer or our customer service center, if the product and accessories are missing or damaged.

Installation Method

- As figure (1), drill 4 holes of Φ10mm horizontally on the wall, hole depth 80mm, and hole spacing as n figure (1),
- Inster a Φ10mm plastic expansion tube into the drilled hole (4pcs 10x75 on both side) and tighten it with 5x80mm wood screw through the hanger hole to secure the hanger to the wall;



- On the time-delayed working mode, wave “” left to right quickly through the gesture sensing Windows at both ends (as shown in figure 5) to exit the time-delayed state, and the air volume will respond according to the above instructions;

- Tap “” and “” for 3 second at the same time to control the turn off/on of gesture sensing function and make " di " sound synchronously.

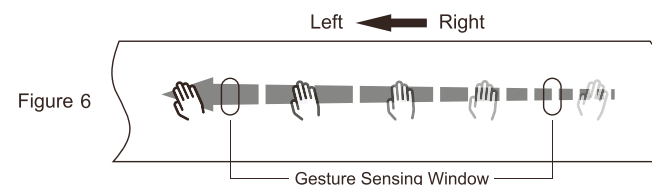
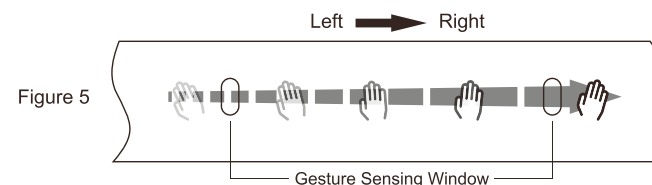

8. Auto-speed

Press “”, the range hood will go into auto-speed mode, The hood will adjust automatically alccording to the smog. Press again , the function will shut off.

9.Auto-clean function reminder

After the range hood has been working for 60 hours in total, the “” icon flashes on the screen of the range hood to remind the user to clean the range hood. The user can choose to activate the automatic cleaning function or cancel it. Long press “” to close / recover Auto-clean function reminder.

10. Wash Function

Tips: Switch off the air button when use hot wash function

Attention

- Detergent will damage the wash system. Do not use detergent for washing;





Note: When the hood is turned off, in order to avoid pinching hands, the movable glass assembly will pause when it is closed to a certain extent, and there will be a beep to prompt at the same time. After the beep is over, the movable glass will continue to close.





5. Stir fry

Press “” button, the 3mins stir fry function will switch on. When the stir fry function is on, press again will shut off the function and switch to Air stage function.

6. Cleaning Lock Function

This function is used for buttons mistakenly switching on when cleaning. Press “” button 3 seconds, cleaning lock function will switch on, “” symbol flashing, and all buttons are locked. Press again “” button for 3 second will switch off the cleaning lock function or wait half hour for automatically shut off.

7. Gesture sensing function

- On the ready mode, Please wave “” left to right quickly through the gesture sensing Windows at both ends (as shown in figure 5), open the range hood (including the light);
- On the working mode, wave “” quickly passes through the gesture sensing Windows at both ends from right to left (as shown in figure 6), and close the range hood (including the light);
- Under the working mode of 1 speed, 2 speed, 3 speed, wave “” left to right through the gesture sensing Windows at both ends (as shown in figure 5), and the 3-minute stir-frying function is enabled;
- On the working mode of stir-frying, wave “” left to right quickly through the gesture sensing Windows at both ends (as shown in figure 5), and auto-speed function is enabled;



- Drilling air outlet, open the air outlet at a distance of 200mm above the air outlet of range hood, and the exhaust outlet should be placed in a sheltered place as much as possible;
- Remove the eight M4 screws at the air outlet on the top of the range hood, take out the air outlet set assembly and the air outlet set gasket from the accessories, align the screw holes at the air outlet on the top of the range hood, and use the removed M4 screws to fix the air outlet set assembly and the air outlet set gasket. Fix the air outlet seat assembly as shown in Figure (4).
- Rotate the bracket screw counterclockwise to lower the bracket 30mm from the highest point, hang the range hood on the bracket, and then rotate the bracket screw clockwise to raise the range hood and fit it under the cabinet (leave a gap of more than 5mm to facilitate the opening and closing of the cabinet door), and screw 1 M4x14 screw into the screw holes on the lower sides of the left bracket to prevent the range hood from slipping and falling.
- Then tighten two pieces of cushions to the corresponding position on the rear of the range hood, hang the range hood horizontally, and then screw an M5x80 screw into the hanger hole to prevent the range hood from slipping off.
- Install the air duct cover (if needed): If the kitchen room has suspended ceiling and flexible duct through the ceiling (the opening size as Figure 2);
Duct cover installation method as Figure 1;
- Extend the flexible duct into the opened air outlet. The flow pipe should be freely bent, and the pipe wall has no concave and convex deformation, the connection is tight and the rotation pieces is smooth and natural;(As figure 3)
- Install oil cup, put the oil cup on the hook at the bottom of the range hood;
- Debugging after installation, After installation, the product should be tested according to the operation instructions in “How To Use” , make sure all the functions work properly during testing.

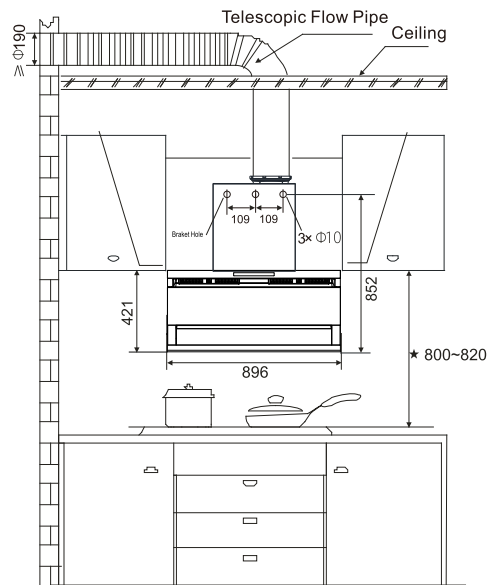

Figure 1(a)

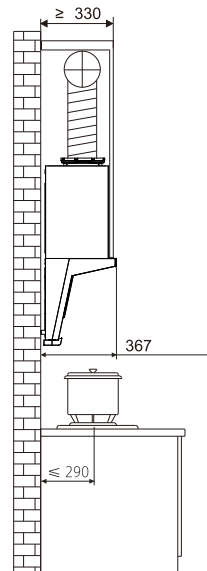

Figure 1(b)

Unit:mm

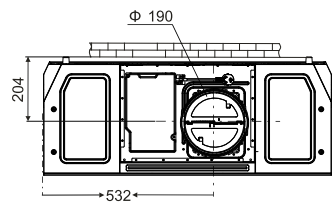

Fig 2

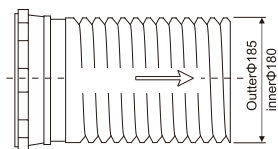

Fig 3

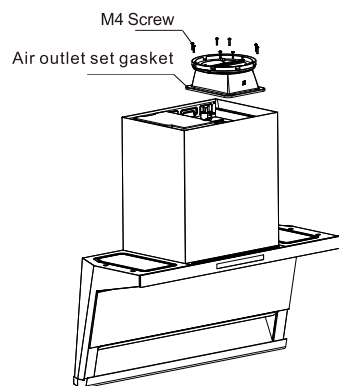

Fig 4



Caution This installation height is only applicable to electriccooker, if installed in gas cooker upper part, installationheight in accordance with the requirements of gascooker installation height.



How To Use

- Control Panel(If the panel symbols are updated, please refer to the actual ones)

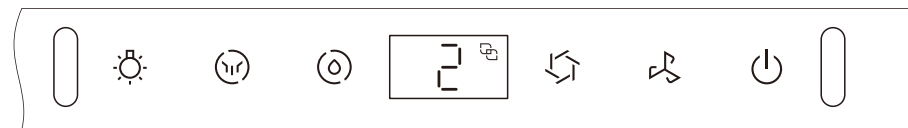

Function Instruction

1.First connect to power

Turn on the power, the key icons light up quickly and then go out, only the “” icon is visible, and enter the dormant state, press the “” key, the movable glass component opens, and enters the standby state.

Note: In standby mode, if no function is turned on for 5 minutes, the smoke machine will automatically shut down and the movable glass assembly will be closed.

2. Air Stage Adjustment

Press “” button, switch on the range hood, continue to press “” will switch among “higher speed/medium speed/lower speed”; Press “” button 2 times the range hood will shut off.

3. Light Switch

Press “” button will illuminate the light; Press “” button again will shut off the light.

4. Shutdown

- When the range hood is activated with the fan function, press the “” button to enter the 3-minute delay shutdown state.

- In the delay state, touching any key will terminate the delay shutdown and execute the function of the key.